

MINICAT 420  
USER GUIDE

minicat

ULTRA LIGHT CATAMARAN



# INTRODUCTION TO YOUR NEW MINICAT

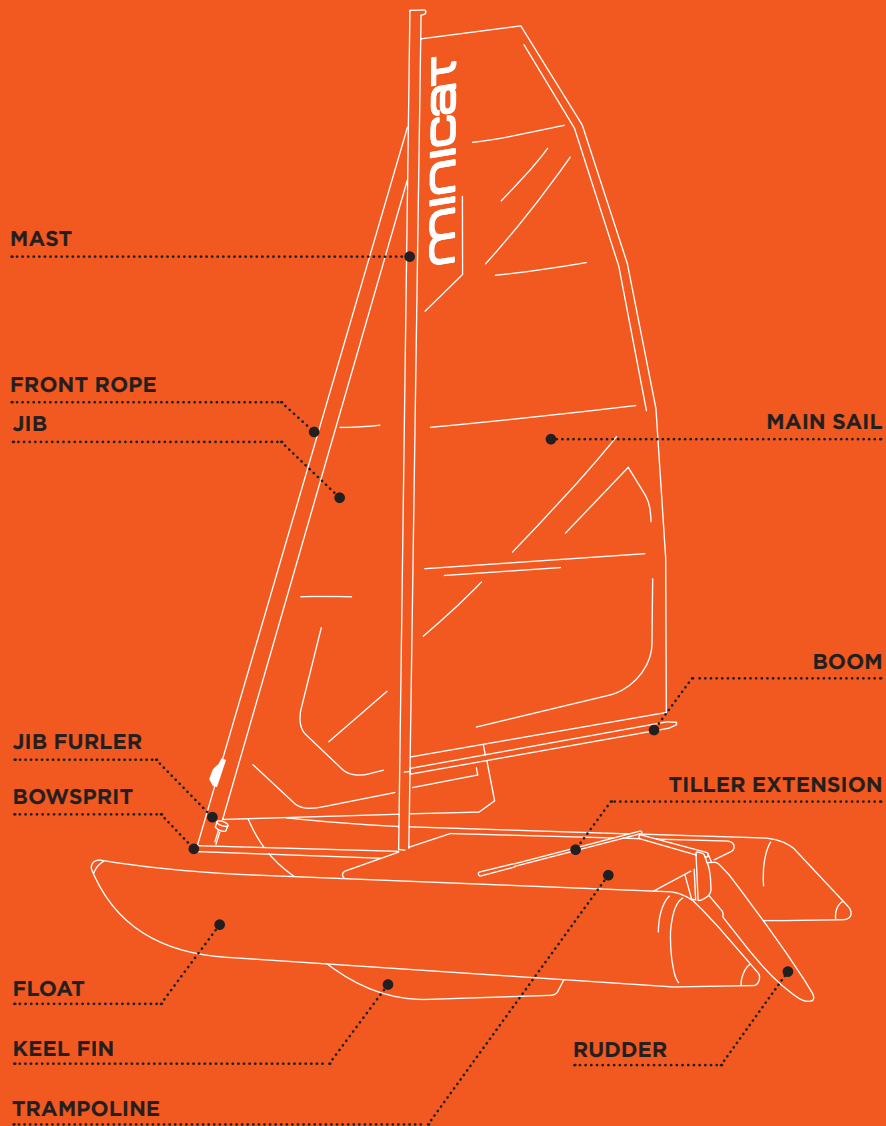

Thank you for purchasing your MINICAT.  
We hope that your new boat will give you many  
hours of fun, enjoyment and pleasure on the water.

Your MINICAT Team

This guide is for use with MiniCat 420 Emotion,  
420 Evoque and 420 Laura Dekker Edition  
models. Whilst there are differences between

these individual models this  
guide takes you through the  
general assembly procedure  
and the model features which  
you will recognise.

**CAUTION!**

*Please remember  
when sailing:  
**ALWAYS SAFETY FIRST***

**This Guide will help you to control your boat easily and safely. It contains a detailed description of the boat and information about its assembly, operation and maintenance. Please, read it carefully, view the accompanying video and get fully acquainted with the boat before using it.**

This User Guide is neither a training manual of sailing safety, nor a sailing course. If this is your first boat, to ensure your comfort and safety familiarise yourself with the operation of the boat before sailing it for the first time. Either your MINICAT retailer, the National Sailing Federation, or your local sailing club will be pleased to recommend you to an appropriate sailing course, or qualified sailing instructors.

Do not set sail if the expected sailing conditions (wind force, wave height) do not correspond to the design category of your boat.

Any changes to your MINICAT which could influence the safety characteristics of the boat, must be performed, verified and documented by a competent and authorised person. The boat manufacturer does not bear the responsibility for any unapproved changes

Always keep your MINICAT well maintained and take into account any deterioration of its condition, which may occur as a consequence of heavy usage or misuse. Despite its strength, your MINICAT may be seriously damaged if it is not used properly. This will jeopardise your safety when sailing.

Always ensure that your MINICAT is assembled precisely according to the instructions, it may be possible to assemble the boat with incorrect positioning, this can result in non-performance or even collapse when sailing.

Always adjust the speed and the heading of the boat according to the sailing conditions (wind force, wave height).

**All persons using any sailing craft must wear life jackets. ALWAYS - SAFETY FIRST**

**CAUTION!**

***Please pay special attention to the selection of your life jacket. It must be certified and equipped with a label containing the information about the carrying capacity and reference to the certificate of safety.***

***Please keep this User Guide in a safe place and give it to the new owner when selling the boat.***

Manufacturer's name and address: MINICAT s.r.o.  
Bilovice 43  
687 12 Bilovice  
Czech Republic

Manufacturer's code: HOC  
Name of the model: MINICAT 420 EMOTION  
Design category of the boat: "D" - Wind max. 4 Beaufort !  
Empty weight of the boat: 48 kg (105 lbs)  
Maximum permitted load: 450 kg (992 lbs)  
(see the carrying capacity)  
Maximum weight of the loaded boat: 498 kg (1095 lbs)

Drive: By sails  
Sails: Main sail + fore sail  
Main sail area: 6.5 sq.m (70 sq.ft)  
Foresail area: 3.2 sq.m (34.5 sq.ft)  
Length of the boat: 4.2 m (13.8 ft)  
Width of the boat: 2.1 m (6.9 ft)  
Height of the mast: 5.05 m (16.5 ft)  
Floats operation pressure: 0.025 MPa (3.6 psi)

1. Norm
2. Permitted loading capacity (Persons + luggage )
3. Suggested operational pressure
4. Serial number
5. EU design category
6. Permitted human capacity
7. Max. wind force
8. Permitted motor output
9. CE-declaration

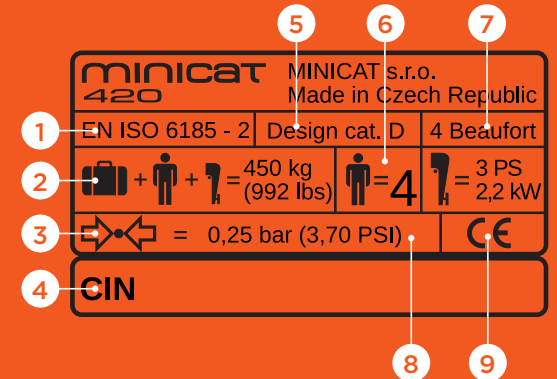

**WARNING!**

***Do not exceed the determined maximum number of occupants.***

***Regardless of the number of occupants on the boat the total weight of occupants and equipment must not exceed the maximum permitted load.***

Maximum wind force:  
**4 Beaufort = 20-28 km/h**  
**3-17 mph**  
**11-15 kn**  
**5.5-7.9 m/s**

Maximum number of occupants:  
**4 adults**

Carrying capacity  
**450 kg**



## Always check your MINICAT before sailing!

Perform a visual check of all parts of the boat before each sailing.

### Protection against falling overboard and how to get back on the boat:

Sit only in the places made for sitting. These are the parts of the frame at the rear half of the floats. The stability of the boat will be reduced if you sit anywhere else.

It is necessary to protect the trampoline from damage, especially rupture by sharp objects, or from careless handling.

For ease of access onto the boat from the water, there are fabric handles on both sides of the floats.

### CARRYING CAPACITY

**The maximum permitted load includes the weight of all persons onboard and any accessories, personal items, equipment or baggage.**

### WARNING!

**Never exceed the maximum permitted load when loading the boat. Always load the boat carefully and allocate the individual weight according to the design of the boat. Avoid the location of heavy objects at the top. Disregarding these instructions may cause the boat to capsize and may result in damage and injury. When sailing always ensure that personal items are secured to the boat.**

# ASSEMBLY OF YOUR MINICAT

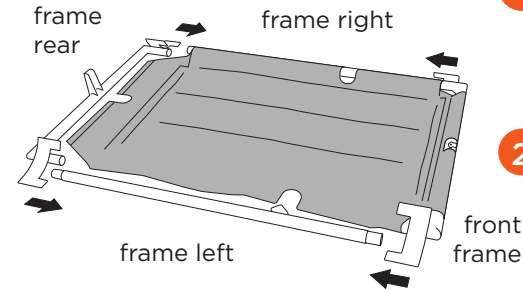

- 1 Carefully remove the individual parts from the bag/s and place on a flat surface, ideally on a grass area to avoid any damage.
- 2 Assemble the frame with the trampoline as shown in the figure. Assemble in the upside-down position (so the frame is on top of the trampoline).

Pass the rope through the lugs on the bottom of the trampoline and tighten it firmly. Fix the end of the rope to the notch. This will help you stretch the trampoline.



Fix the keel fins on the bottom of the floats (un-inflated). Push the fins into the pockets on the floats firmly.





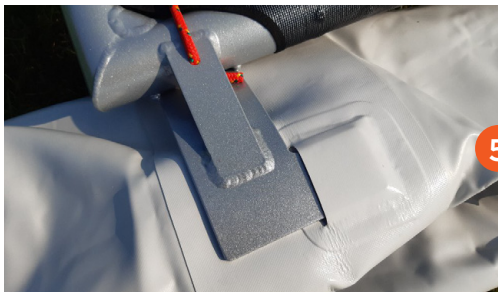

5

Attach the frame to the uninflated floats. Attach the frame by pushing the metal 'flags' into the pockets on the floats.



6

Now inflate the floats to reach the operating pressure.

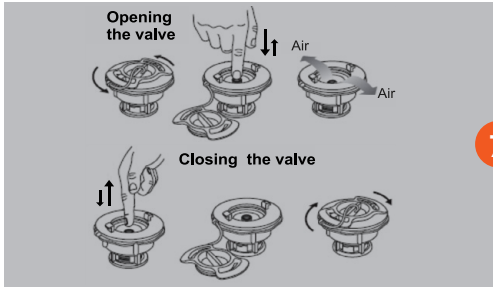

7

Before inflation, check the status of the valves. Set the valves to the closed position.



8

Screw the crossbar ('stay-bold') onto the front frame tube and prepare the longitudinal centre tube (bowsprit) for mounting.

STAY - BOLD



9

Unwrap the bundle of stainless-steel ropes and attach them using the snap hooks to the frame as shown in the diagram. Slip the end with a plastic plug onto the end of the longitudinal centre tube (bowsprit).

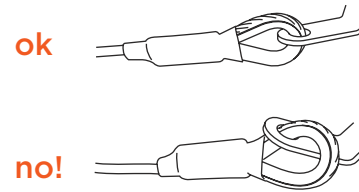
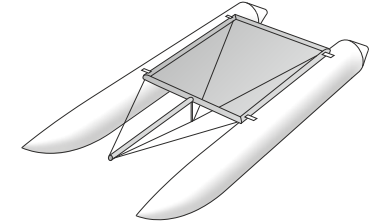

ok

no!

ok

no!



10

Assemble the mast. The individual components are simply inserted into one another.



Interlace the lifting ropes (halyards) with a pulley on the top of the mast. Before erecting the mast, fix the lateral fastening ropes to the upper part of the mast as well as the front rope. Attach the other ends of lateral guy-ropes to the frame using the shackles. Attach the front rope to the snap hook on the bowsprit.

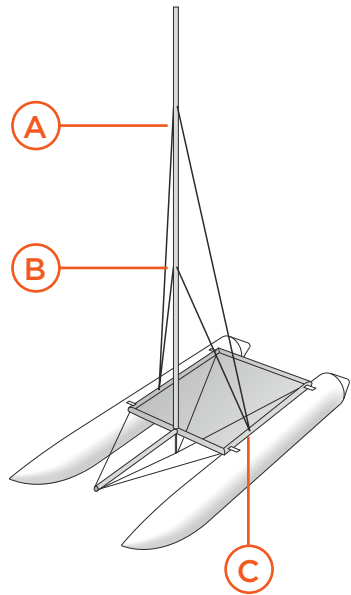

Now you can erect the mast. By tightening the front rope and locking it in the notch you can achieve thorough tightening for all the ropes and the mast until completely taut. Screw in the stretchers on the lower stainless ropes in such a manner so that these are tightened and completely taut.



11

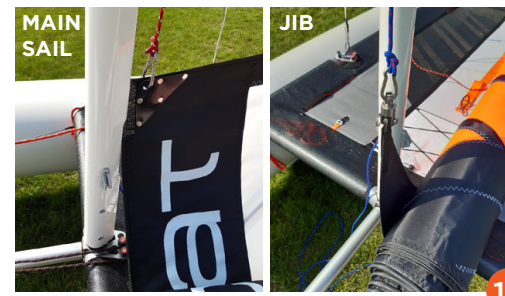
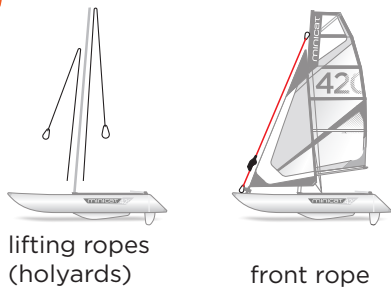

12

Unpack the jib and fix the lifting rope (jib halyard) to the top of the jib. Then pull up the jib and its bottom corner with the jib furler fix with a carbine as shown on the photo below.



13



Heave out the sail in a vertical direction by tightening the rope between the boom and the mast (vang).

Lace the jibsheets through the grommets on the frame and tie a knot to prevent them from pulling out.



Mount the rudder. Attach the rudder assembly to the frame simply by running two spigots with safety locks to secure.



15



16

Attach the stays of the mainsheet to the sail using a Carabine

**WARNING !**

*It is recommended after each sailing, to treat the connections of the mast using silicone oil.*

*When exposed to the sun, the pressure in floats increases - let air out gradually!*

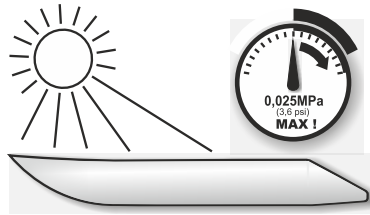

**WARNING !**

*Water should never come inside of the tubes. In case this happens please empty as soon as possible and dry throughout*

*Water inside of the tubes can cause a damage to the inner rubber of the tube and this can cause I-beam damages as well.*

*If you experience a loss of pressure of 20% of operating pressure inside a 24 hour period when external temperature is constant it is considered to be completely normal and no reason for a complaint to the manufacturer or a warranty claim.*

**WARNING !**

*There is a possibility that the flat valve can become a little lose after the first few inflations, and that can result in a little air escape around the valve (being a result of the stretching and contracting of the boat skin). In case this happens with your boat, it is sufficient to turn the valve with the valve key by about one quarter to one half a turn until the resistance becomes too great.*

*If the boat is standing still on a shore for a longer periods of time, please dismantle the keel fins or use the special stands (see our Spare Parts & Accessories Catalogue) under the floats which will prevent the pressure on the floats. You will avoid a possible damage of the keel fins and floats. We also recommend the purchase of the boat cover accessory to protect your boat whilst being left assembled*

*Maximum operating pressure in the floats (air chambers) is 0.025 MPa (3.6 psi). If there is an increase of the ambient air temperature (due to the heat of the sun) the air pressure inside the floats can increase. The air pressure of the floats should be checked and air released if necessary to avoid eventual damage.*

*Before setting sail it is advisable to familiarise yourself with any local regulations or restrictions for the piece of water in which you intend to operate.*

*MINICAT is not intended to be towed behind a motorised craft. It must not be towed, slide moved, or otherwise extensively loaded.*

*Any sharp objects must be securely packaged.*

*Valuable items and personal effects must be placed in a waterproof package and placed in the pockets on the trampoline. We recommend your purchase of the additional front trampoline.*

*If the boat is standing still on a shore for a longer periods of time, please dismantle the keel fins or use the special stands (see our Spare Parts & Accessories Catalogue) under the floats which will prevent the pressure on the floats. You will avoid possible damage of the keel fins and floats..*

*Bright sunlight will eventually have a deteriorating effect on the rubber surface of the floats, therefore wherever possible when your MINICAT is not in use it is advisable to leave the boat out of direct strong sunlight. We recommend your purchase of the optional boat cover.*

*When sailing on large open water (sea, lake) pay close attention to the wind directly from the coast. It is possible to be blown offshore.*

*MINICAT must not be used in bad conditions, for example, low visibility, night, fog, rain. ALWAYS SAFETY FIRST.*

# INSTRUCTIONS FOR DRYING, STORAGE, CLEANING AND MAINTENANCE OF YOUR MINICAT

After sailing and before storing your MINICAT it is necessary to rinse the boat using water and a mild soap or detergent, and then allow the boat to dry out thoroughly. After sailing in salt water it is necessary to wash the boat thoroughly with fresh water. It is recommended to clean all parts from dirt, sand and other impurities using an absorbent cloth. Please note that oil, petrol, acetone, kerosene, paraffin and similar solvents and chemicals are not compatible with the rubber layer on the surface of the boat and must be avoided to prevent damage.

Before storing your MINICAT and from time to time, we recommend that you clean the boat thoroughly and treat the surface of the rubber floats. The 'MINICAT Maintenance Kit' includes everything you need for the care of your MINICAT including cleaning and preserving fluid, lubricant and silicone oil.

Carefully pack the dry, deflated floats, cleaned from sand and dust, so that the number of folds will be as few as possible. The folds especially at the edges of the packed float have to be protected to prevent unnecessary wear. Care should also

be taken of the cover of the inflation valve, and to avoid any damage to the floats during packaging.

We recommend that you do not leave your boat packed for long periods of time. To prevent deterioration to the floats we it is necessary to inflate them periodically.

Pay particular attention when putting single parts into the bag to prevent any damage.

**Store the packed boat in a dry space protected from direct sunlight and adverse temperatures (rec: 10-25 °C). Avoid any load or strain being placed on the boat during storage (putting any heavy objects on top of it, etc.) Careful treatment and good maintenance will extend the life of your MINICAT.**

## Righting a capsized boat (Turning Turtle)

In case of overturning the MINICAT follow these instructions:

1. Release the jib and the main sail to the maximum to assure the least possible resistance of the sails when righting the boat. On the MINICAT Instinct - wind in the jib fully.
2. Stand on the underside of one float then and pull on the mast line and the handle on the other float. Be careful to prevent damage to the keel fins. For added stability stand with your legs apart.

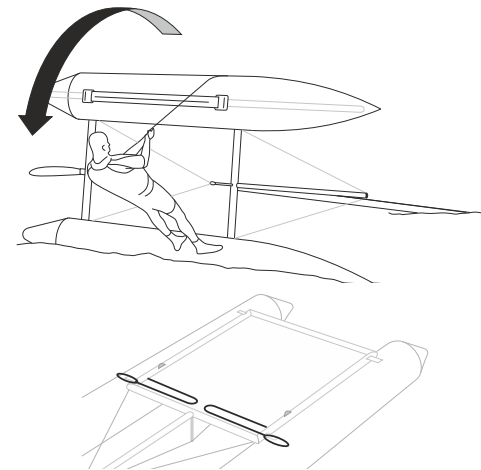

After righting the boat use the handles on both sides of the floats to get back on board.

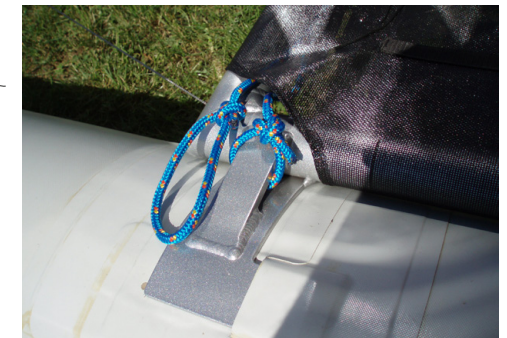



# REPAIR OF YOUR MINICAT

Damage to the MINICAT floats can be easily repaired using the supplied **'MINICAT Repair Kit'**.

## Repair procedure:

1. Mark the damaged area on the boat and select the patch according to the size of the damage.
2. The surface of the patch and of the damaged area must be dry, clean, dust-free and without trace of previous adhesive.
3. De-grease both the patch and the damaged area using acetone or petrol.
4. Apply a thin layer of adhesive to both surfaces.
5. When the adhesive is dry to touch attach the patch to the damaged area and apply pressure.

After minor repairs (punctures), it is possible to re-inflate the boat and to continue sailing after just 60 minutes, with larger repairs it is recommended to wait for 24 hours. With more complicated repairs you are recommended to return your MiniCat to your supplier, to the manufacturer, or to an accredited repair-shop. Careful treatment and maintenance can extend the life of your MINICAT.

**The manufacturer's warranty period is 24 months from the date of the sale. All warranty repairs are carried out by a designated, authorised repairer or by the manufacturer. Upon purchase of your MINICAT you must return the enclosed WARRANTY REGISTRATION FORM directly to MiniCat Worldwide to validate and commence the period of your warranty.**

Worldwide distributor:  
Moravian Exports, s.r.o.  
Kaly 37  
594 55 Dolní Loučky  
Czech Republic  
Tel: +420 776 749 175  
Email: info@minicatamaran.eu

Manufacturer:  
MINICAT s.r.o.  
Bílovice 43  
687 12 Bílovice u Uh. Hradiště  
Czech Republic  
Tel: +420 739 669 330  
Email: minicat@seznam.cz

# RECOMMENDED PACKING

To avoid unnecessary damage while storing or transporting your boat please follow the instructions on recommended packing below:

## 1. bag



1. - 1x Frame - rear
2. - 1x Frame - front + Trampoline
3. - 2x Float
4. - 1x Stainless steel ropes
5. - 1x Shroud
6. - 1x Front rope
7. - 1x Accessories (USB stick, Repair Kit, User guide...)

## 2. bag



1. - 1x Mast
2. - 1x Bowsprit
3. - 1x Staybold
4. - 1x Tiller extension
5. - 2x Keel fin
6. - 2x Frame - side
7. - 1x Sails
8. - 1x Complete rudder
9. - 1x Inflation pump

**WARNING!**  
*The total weight of the assembled boat is 48 kg*

*When counted together with the bags, inflation pump and spare parts to total weight comes to 52 kg*

# CAUTION!

**Sailing can be very dangerous and personally exhausting. Therefore, the user of this product must realise, that not following safety precautions may result in serious injury, or even in death. Therefore when using this product pay close attention to following safety precautions:**

1. Get well acquainted with the operation of this design of boat.
2. Ensure that you have first aid training with certification and have emergency/first aid equipment with you when you sail.
3. Always use a quality certified life jacket.
4. Before each time you sail check your equipment for functionality and that it does not show any signs of damage.
5. Do not overestimate your abilities on the water; take care of yourself.
6. Ensure your state of health with a doctor before you go sailing.
7. Always observe the manufacturer's recommendations regarding the use of this product.
8. Never use this product after taking alcohol, drugs or medication or when tired.
9. Before using this product read the User's Guide carefully.
10. Always pay attention to sea winds and currents.
11. The user of this product must be familiar with the basic sailing skills and must be aware of the risks attached to this sport.

**ALWAYS - SAFETY FIRST**

# USEFULL KNOWLEDGE

## Giving Way in Sailing

All types of vessels on the water are governed by the International Regulations for Preventing Collisions at Sea, frequently abbreviated as COLREGS. The entire set of rules is highly complicated, however, when you start sailing, it is sufficient to be familiar with the basic rules that are listed here.

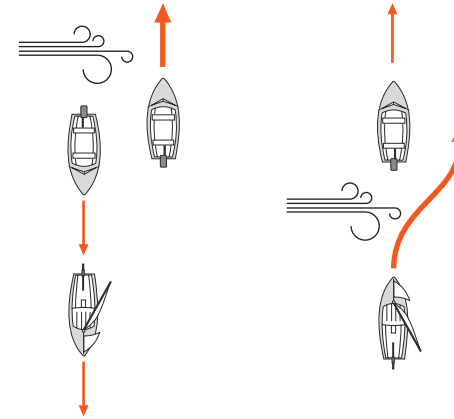

## The rules for navigation in a channel (or canal)

All vessels must stay to the right side in channels or canals, so that they meet on their port side.

## Overtaking rule

An overtaking vessel must keep out of the way of the vessel being overtaken, even in the case of a sailing vessel overtaking a power-driven vessel.

The port rule: A vessel sailing port side (with the boom on the port side) has the pass over a vessel sailing starboard side. The vessel sailing starboard side must give way to a vessel sailing port side.

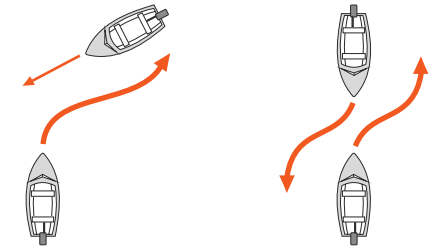

A vessel that arrives from the right is given way in the same way as on the road.

When power-driven vessels meet head-on, they turn their course to the right and meet on their port side.

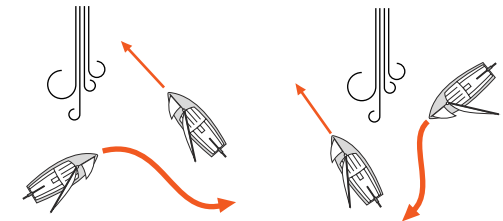

The starboard side vessel alters her course in order to sail behind the stern of the port side vessel.

The windward vessel shall avoid the leeward vessel and navigate in order to sail behind her.

## GOOD TO KNOW!

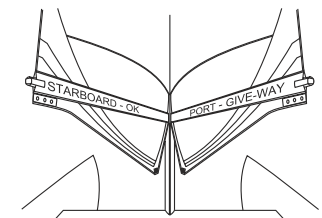



# BEAUFORT SCALE

Beaufort no.	Description	Wind speed	Wave height	Sea condition	Land condition
0	Calm	< 1 km/h < 1 mph < 1 kn < 0.3 m/s	0 m 0 ft	Flat	Calm. Smoke rises vertically
1	Light air	1.1 - 5.5 km/h 1-3 mph 1-2 kn 0.3 - 1.5 m/s	0 - 0.2 m 0 - 1 ft	Ripples without crests	Smoke drift indicates wind direction, still wind vanes.
2	Light breeze	5.6 - 11 km/h 4 - 7 mph 3 - 6 kn 1.6 - 3.4 m/s	0.2 - 0.5 m 1 - 2 ft	Small wavelets. Crests of glassy appearance, not breaking	Wind felt on exposed skin. Leaves rustle, vanes begin to move.
3	Gentle breeze	12 - 19 km/h 8 - 12 mph 7 - 10 kn 3.4 - 5.4 m/s	0.5 - 1 m 2 - 3.5 ft	Large wavelets. Crests begin to break; scattered whitecaps	Leaves and small twigs constantly moving, light flags extended.
4	Moderate breeze	20 - 28 km/h 13 - 17 mph 11 - 15 kn 5.5 - 7.9 m/s	1 - 2 m 3.5 - 6 ft	Small waves with breaking crests. Fairly frequent whitecaps.	Dust and loose paper raised. Small branches begin to move.
5	Fresh breeze	29 - 38 km/h 18 - 24 mph 16 - 20 kn 8 - 10.7 m/s	2 - 3 m 6 - 9 ft	Moderate waves of some length. Many whitecaps. Small amounts of spray	Branches of a moderate size move. Small trees in leaf begin to sway.

# SAILOR KNOTS

## Bowline (also known occasionally as the Boiling knot)

The bowline creates a fixed loop at the end of a rope, making it useful for fastening a mooring line to a post or ring. It's also the knot most commonly used for rescue ropes, as a trapped person can tie the loop around them and then be hoisted up with the rope.

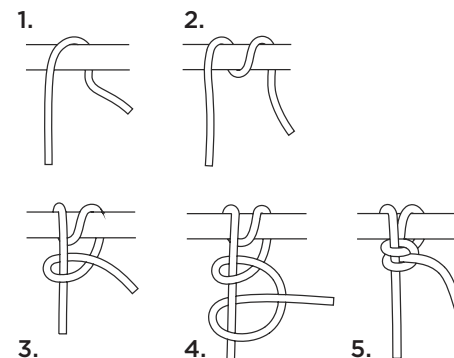
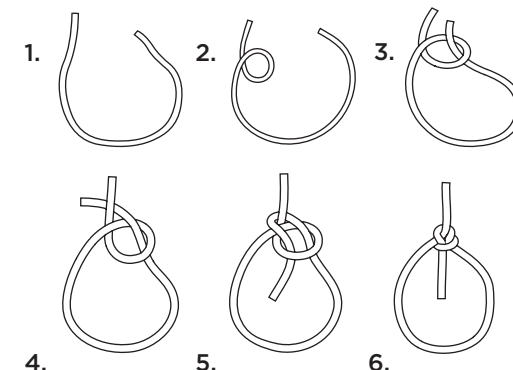

## Sheet Bend (also known as becket bend, weaver's knot and weaver's hitch)

The sheet bend is useful for joining together two different ropes. It's best to use this knot for ropes which are under load, as it can work loose on ropes which are not under any strain. This is the preferred knot instead of the Reef Knot.

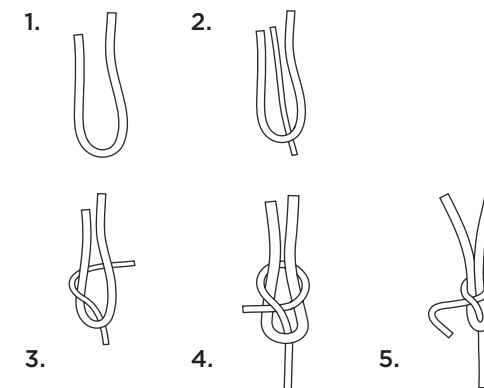

## Round Turn and Two Half Hitches

While a bit of a mouthful, this useful knot is used to secure a rope to a fixed object such as a pole. The tail of the rope is wrapped around an object (this is the 'round turn') and secured to the standing part with two hitches (the tail end is passed over and under the standing part, twice).



# Certificate of Conformity

No. 01 - 2019

Manufacturer:

**MINICAT s.r.o.**

**Bilovice 43**

**687 12**

**Company Registration Number: 08178895**

Registered MIC (Manufacturer's Identity Code)

according to ČSN EN ISO 10087, Art. 42 - "HOC"

declares and certifies on its exclusive responsibility that the product:

## **Recreational Craft - MINICAT 420**

determined for sailing in protected offshore waters, large lakes, river mouths, bays, etc., is designed and produced in conformity with the requirements of **ČSN EN ISO 6185**, issued by the European Committee for Standardization (CEN) on 10 November 2001 and is safe under the conditions of the above - stated use.

The manufacturer declares that all the products put on the market conform to the technical documentation and to the basic requirements.

Conformity assessment has been conducted according to:

**ČSN EN ISO 6185**

**ČSN EN ISO 10240**

**ČSN EN ISO 14945**

**ČSN EN ISO 10087**

**Directive 94/25/ES**

The product meets all the requested values and parameters and all the required tests have been successfully carried out.

In Uherské Hradiště on 20.10.2019

MgA. Martin Horák  
CEO

**minicat** s.r.o.

IČ: 08178895, DIČ: CZ08178895  
687 12, Bilovice 43

# ENJOY YOUR NEW MINICAT AND PLEASE REMEMBER: ALWAYS SAFETY FIRST

 @minicatamaran

 /minicat

 @minicatsailing

 search: MINICAT

[www.minicatamaran.eu](http://www.minicatamaran.eu)





**minicat**  
ULTRA LIGHT CATAMARAN

© All Rights Reserved

